

ZANUSSI

 Electrolux

TUMBLE DRYER ZDC 5375 W

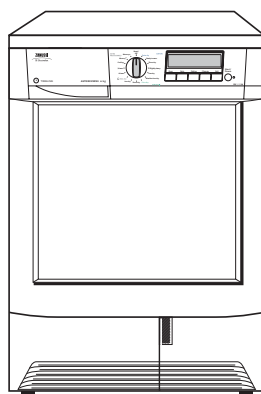

 **Unpacking:** see page 23



Important Safety Information

It is most important that this instruction book should be retained with the appliance for future reference. Should the appliance be sold or transferred to another owner, or should you move house and leave the appliance, always ensure that the book is supplied with the appliance in order that the new owner can get to know the functioning of the appliance and the relevant warnings.

These warnings have been provided in the interest of safety. You **MUST** read them carefully before installing or using the appliance.

Installation

- This appliance is heavy. Care should be taken when moving it.
- It is dangerous to alter the specifications or attempt to modify this product in any way.
- Any electrical work required to install this appliance should be carried out by a qualified electrician or competent person.
- Care must be taken to ensure that the appliance does not stand on the electrical supply cable.
- If the machine is situated on a carpeted floor, please adjust the feet in order to allow air to circulate freely.
- If the tumble dryer is placed on top of a washing machine, it is compulsory to use the stacking kit (available as an accessory).
- **Danger of explosion:** Never tumble dry items that have been in contact with inflammable solvents (petrol, methylated spirits, dry cleaning fluid and the like). As these substances are volatile, they could cause an explosion. Only tumble dry items washed with water.
- Risk of fire: items that have been spotted or soaked with vegetable or cooking oil constitute a fire hazard and should not be placed in the tumble dryer.
- If you have washed your laundry with stain remover you must execute an extra rinse cycle before loading your tumble dryer.
- In order to avoid danger of fires caused by excessive drying, do not use appliance to dry the following items:
Cushions, quilts and the like (these items accumulate heat).
Items containing rubber foam or materials similar to rubber foam.

Child Safety

- This appliance is designed to be operated by adults. Children should not be allowed to tamper with the controls or play with the product.
- Pets and children have been known to climb into tumble dryers. Please check your drum before use.
- Keep all packaging well away for children.
- Leave the door slightly ajar when the appliance is not being used. This will allow the seal to be preserved.
- Clean fluff filters after using tumble dryer. To prevent fire risks, do not use the appliance if the fluff filters are damaged.
- Do not allow fluff to accumulate around the dryer.
- Under no circumstances should you attempt to repair the machine yourself. Repairs carried out by inexperienced persons may cause injury or serious malfunctioning. Contact your local Service Force Centre. Always insist on genuine Zanussi-Electrolux spare parts.

Use

- Do not overload the appliance (see programme chart).
- Clothes which are dripping wet should not be placed in the dryer.
- As some bulky items such as duvets and eiderdowns should be dried in large commercial machines because of their bulk, check with the manufacturer of the item if it is suitable for drying in a domestic machine, even if the dry weight of the item is within the limit advised.
- Please make sure that no gas lighters or matches have accidentally been left in pockets of garments to be loaded into appliance.

Contents

For the User

Important Safety Information 2

- Installation
- Child Safety
- Use

Your New Tumble Dryer 4

Description of the Appliance 4

The Control Panel 5

- Programme/Time Selector Dial 5
- Display 5
- Door Release Button 5-6
- Spin Speed Button 6
- Option, Change, Exit Button 6-9
- Start/Pause Button 10

Programme Chart 11

Operating Sequence 12-14

Hints & Tips on Drying 15

Maintenance and Cleaning 16

- External cleaning 16
- Cleaning the door 16
- Cleaning the filters 16
- Cleaning the condenser unit 16-17
- Emptying the water reservoir 17
- Cleaning the drum 17

Something Not Working 18

Service and Spare Parts 19

Customer Care 19

Guarantee Conditions 20

For the Installer

Installation Instructions 21

Technical Specifications 21

Adjusting the Level of Conductivity 22

- Unpacking 23
- Positioning 23
- Stacking kit (optional accessory) 23
- Door reversal 23
- Electrical connection 23-24

Guide to use the Instruction Book

The following symbols will be found in the text to guide you throughout the instructions:



Safety instructions



Hints and tips



Environmental information

Your New Tumble Dryer

This tumble dryer will give your wash that soft, relaxed feel whatever the weather.

Extremely high quality standards both during development and manufacturing guarantee a long service life for your appliance.

Maximum economy in the operation of your dryer is achieved through very economical electricity consumption and short drying times.

Energy saving tips

To save energy we recommend that you follow these hints:

- Try to load the maximum capacity of the machine as small loads are **uneconomical**.
- Always load well spun laundry. The higher the spin speed, the lower the electricity consumption and the shorter the drying times.
- Do not over-dry laundry, this avoids creasing and saves energy.
- Clean the filters regularly to avoid excessive drying times and high electricity consumption.
- Ventilate the room well. The room temperature should not exceed +35°C during drying.

In the interest of the environment

- Materials marked with the symbol  are recyclable.
- Check with your local Council or Environmental Health Office to see if there are facilities in your area for re-cycling this appliance.

- When the appliance is to be scrapped, cut off the power supply cable and make the door closing device unusable to prevent young children from being trapped inside.
- Help to keep your country tidy - use authorised disposal sites for your old appliance.

How do we help to protect the environment? We use recycled paper!

• Old appliance

The symbol  on the product or on its packaging indicates that this product may not be treated as household waste. Instead it shall be handed over to the applicable collection point for the recycling of electrical and electronic equipment. By ensuring this product is disposed of correctly, you will help prevent potential negative consequences for the environment and human health, which could otherwise be caused by inappropriate waste handling of this product. For more detailed information about recycling of this product, please contact your local city office, your household waste disposal service or the shop where you purchased the product.

Description of the Appliance

- 1 Control panel
- 2 Water reservoir
- 3 Fluff filters
- 4 Rating Plate
- 5 Condenser unit
- 6 Adjustable feet

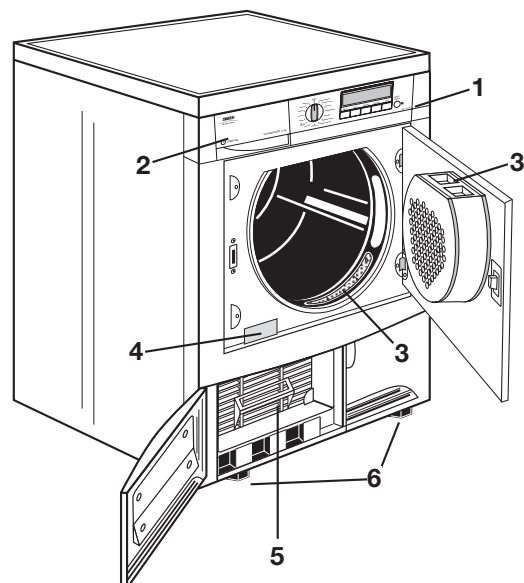

The Control Panel

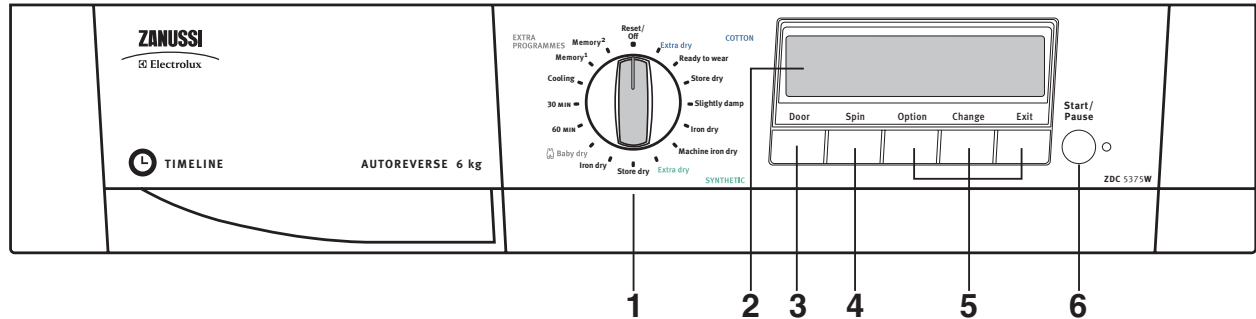

1 Programme/Time Selector Dial

Allows you to select electronically controlled or time controlled drying.

Turn the dial to the required programme or time.

The selector dial can be turned either clockwise or counterclockwise.

Electronically controlled drying (automatic)

The appliance runs these programmes with the help of probes which detect the degree of dampness of the laundry.

Simply select the programme according to the type of laundry and degree of drying required.

Time controlled drying

This can be used to finish off drying if necessary. Select the 60 minute programme for cottons or the 30 minute programme for synthetics.

To cancel a programme which is running, turn the programme selector dial to **“RESET/OFF”**.

At the end of drying, turn the selector dial to **“RESET/OFF”** to switch the machine off before removing the laundry.

The selector dial is divided into 4 sections:

- Cotton (blue section)
- Synthetics (green section)
- Time controlled drying (grey section)
- Memory 1, Memory 2 (green section)

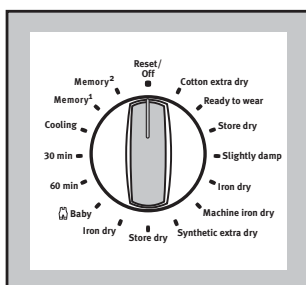

2 Display

The DISPLAY is used for setting a large number of functions and combine them with each other using only a few control elements (1 programme selector dial and 6 buttons). This simple control method is made easy thanks to the interactive display.

Interactive means that the dryer display changes to reflect each step you have entered. This ensures that only those settings that make sense are made. You are able to see the current settings at any time in the information panel and in the option row.

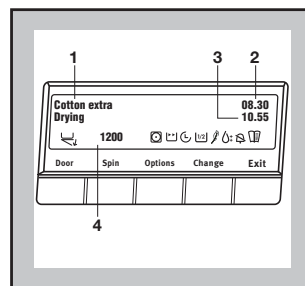

1. Information panel shows the current settings and the current phase of drying cycle.
2. Real time clock
3. End cycle time
4. Selection shows the spin speed of your washing machine and the options selected.

3 DOOR RELEASE Button

Press this button to open the door.

The  icon appears above the relative button.

If the door is opened while the programme is running the appliance immediately stops drying. The «Pause» message appears on the display, the  icon is shown above the Door button and the START/PAUSE button starts flashing.

Opening the door by means of this button is possible only if the tumble dryer is on (programme selector dial set to a programme or drying time).

If you open the door during a programme, in order to restart the programme you must press the Start/Pause button again after having closed the door. The  icon appears on the display above the relative door button.

4 SPIN SPEED Button

Press this button repeatedly until the value shown on the display matches the speed the laundry items were originally spun in your washing machine.

Depending on the type of laundry the spin speeds are the following:

- COTTONS:800-900-1000-1100-1200-1300
1400 1500-1600 rpm.
- SYNTHETICS: ..800-900-1000 rpm.
- JUMPERS (BABY DRY): 800-900-1000-1100-1200 rpm.

If you do not know the exact laundry spin speed you can choose blank (no value on the display). The tumble dryer will dry the laundry using a default factory drying cycle.

Using this option you could decrease the drying cycle time, saving energy.

If you have selected a time controlled programme (60 min. or 30 min.) you could not use this option because it has been selected a fixed time of drying.

If you try to press this button a warning message «Selection error» appears in the display.

5 OPTION, CHANGE and EXIT Buttons

Option button allows you to move through the option icons.

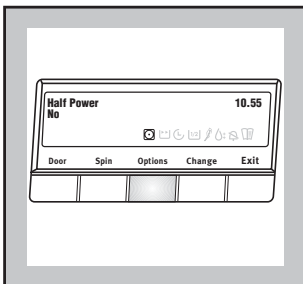

Change button allows you to select/change the status of the different icons.

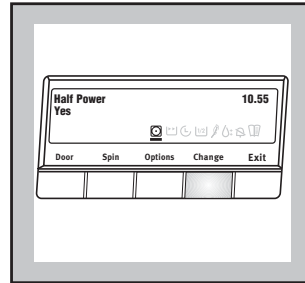

Exit button allows you to return to the previous selection.

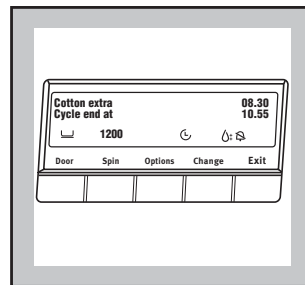

Depending on the programme, different functions can be combined. These must be selected after choosing the desired programme and before pressing the START/PAUSE button.

By depressing the «**Option**» button, all the symbol icons, allowed for the selected programme, will appear in the display.

The first option  (Half Power) will start flashing. Its name and status will appear on the display.

If you want to change the option status, press «**Change**» button. A line will appear below the selected icon, indicating that the option is set.

To select the other options press again the «**Option**» button and proceed as before.

Once you have completed the selection of the options, press the «**Exit**» button, the selected icons will remain fixed on the display.

Note: To modify the already chosen option selections, repeat the previous procedure.

Half Power

Selecting this option allows drying to be performed at a lower temperature, for delicate items.

The corresponding  icon appears on the display during set up mode and the drying cycle.

A dash is shown under the relative icon to indicate that the option has been selected.

This option can also be used for time controlled drying.

This option **cannot** be selected with Quick Dry .

Quick

By selecting this option the drying time is reduced in the following COTTON programmes:

- EXTRA DRY
- READY TO WEAR
- STORE DRY

This option **cannot** be selected with **Half Power**  and **Dry Level**  option.

Delay Start

This option makes it possible to delay the starting of the drying programme by 30 min - 60 min - 90 min, 2 hours and then by 1 hour till 20 hours. You can modify the status of the delay pressing the «Change» button sequentially. The delay you have selected is indicated in the display.

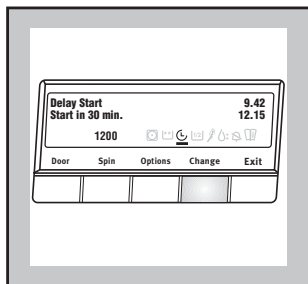

You must select this option after you have set the programme and before you press the START/PAUSE button.

You can cancel the delay time at any moment, before you press the START/PAUSE button. If you have already pressed the START/PAUSE button and you wish to cancel the delay time proceed as follows:

1. set the dryer to PAUSE by pressing the START/PAUSE button;
2. deselect the Delay start option, changing the status;
3. press the START/PAUSE button to start the programme.

Important!

The selected delay can be changed only after selecting the drying programme again.

If you wish to load other laundry to be dried after having selected the delay time option:

- open the door, pressing the relative button
- load your laundry
- press the START/ PAUSE button, after having closed the door.

Half Load

This option can be selected when the load inside the drum is less or equal to the half load weight declared

by the programme selected.

This option will decrease the duration of the drying phase and it allows you to save energy.

This option **cannot** be selected with time controlled drying (30 min. and 60 min.).

Long Anticrease

To be used when you are not able to remove your dried laundry just after the end of the drying cycle.

Selecting this option the anticrease phase will be prolonged by an hour.

Dry Level

Selecting Dry Level option, you can choose 3 different degrees of humidity that your laundry retains.

To select the requested humidity degree press the «Change» button repeatedly.

When on the display appears:

Increased Dry

You have chosen the medium degree of drying. Drying cycle time will increase by approx. 3 min.

Very Dry

Provides the highest degree of drying. Drying cycle time will increase by approx. 6 min.

Reduced Dry

Provides the lowest degree of drying. Drying cycle time will decrease by approx. 2 min.

To confirm your choice press «Exit».

This option **cannot** be selected with **Quick** option .

No Buzzer

A buzzer sounds:

- when selecting the programme
- when an incorrect option selection is made
- when the programme selector dial is turned to another position during the programme or when you press an option button during the cycle
- at the end of the programme
- when the water reservoir is full
- if the machine is not working correctly
- when the small door at the bottom is open.

By selecting this option, pressing «Change» button, the acoustic signal is switched off:

- at the end of the programme
- when the water reservoir is full
- if the machine is not working correctly
- when the small door at the bottom is open.

To confirm this option press «Exit» button.

Set Up menu:

Menu option is used for selecting various basic settings without affecting the particular drying programme. These basic settings will remain active until they are deselected/modified.

To move through the different Menu settings use the «Option» button. To change/confirm the selected setting use the «Change» button.

Memory

Programme settings that are frequently used can be saved. There are 2 memory spaces available for this purpose. The saved programme can be selected in the same way as any other drying programme by means of the selector dial.

Example: Cotton Extra Dry, 1200 rpm, No Buzzer and Dry Level option).

1. Select the cycle and programme settings.

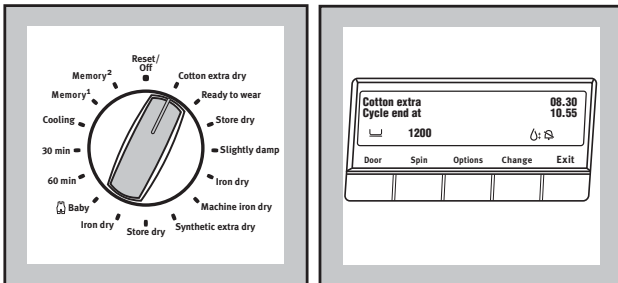

2. Enter the Menu option and select one of the memory positions. «Store programme?» message will appear in the display.

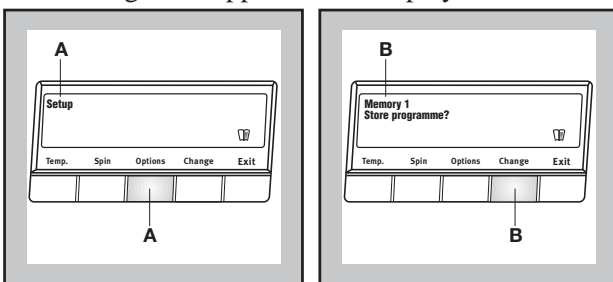

3. To memorise the selected programme press the «Change» button. «Stored» message will appear in the display.

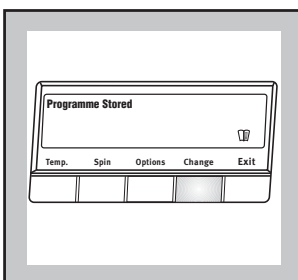

To change the memorised programme setting repeat the procedure from the beginning.

Sound

The sound setting permits you to modify the volume of the sound emitter. You can choose between different levels: low, no sound and normal.

Example:

1. Enter the Menu option and select the sound setting.

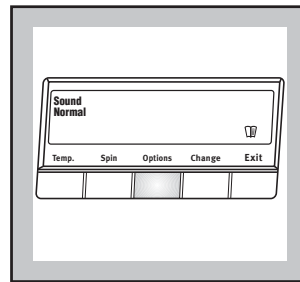

2. Use the «Change» button to select the desired level.

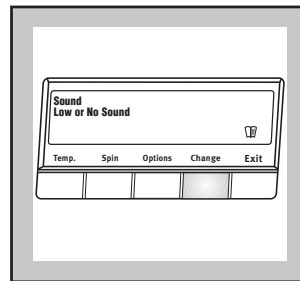

Water Hardness

You can change the water hardness choosing 3 different degrees (see the chapter «Adjusting the level of conductivity» on page 22).

Language

You can change the language setting if you would like the indicators in the display to appear in a different language.

Example:

1. Enter the Menu option and select the Language setting.

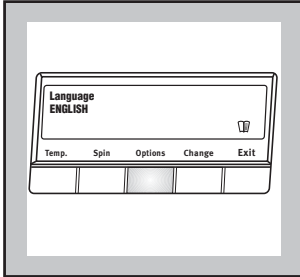

2. Press the «Change» button to select the desired Language.

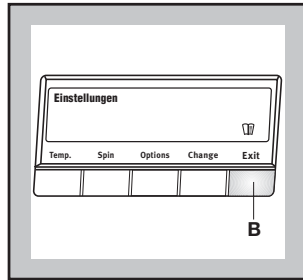
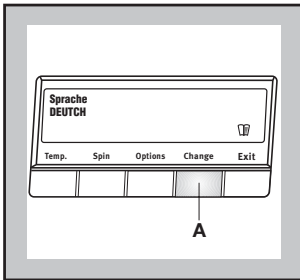

Clock

The clock setting permits you to modify/set up the current time. It is important to keep it updated as the current END Cycle Time depends on it.

Example:

1. Enter the Menu option and select the Clock setting.
2. With a short/single time press of the «Change» button, the time varies minute by minute. With a continue pressure of the «Change» button, the time varies 10 minutes by 10 minutes.

Contrast

The Contrast setting allows you to modify the optical characteristic of the display.

Example:

1. Enter the Menu option and select the Contrast setting.
2. Use the «Change» button to set up the desired contrast level.

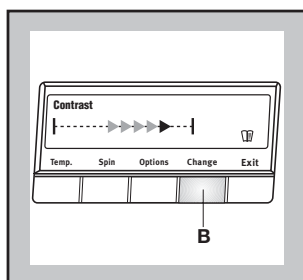
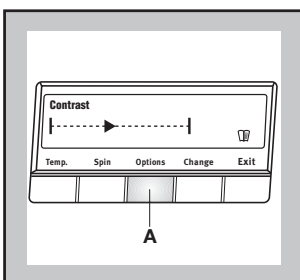

Brightness

The Brightness setting allows you to modify the backlight intensity of the display.

Example:

1. Enter the Menu option and select the Brightness setting.
2. Use the «Change» button to set up the desired brightness level.

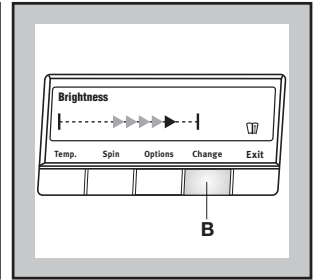
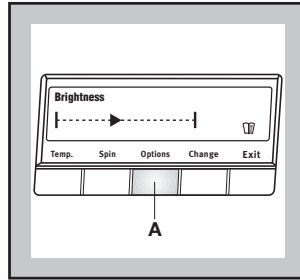

Note:

At the end of the programme if no button is pressed for approximately 10 minutes the backlight intensity goes off.

6 START/PAUSE Button

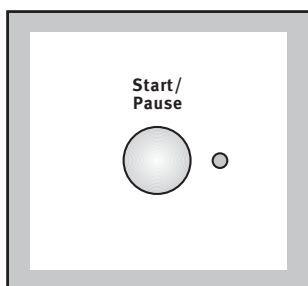

This button has 2 functions:

- Start: after you have selected the desired programme and options, press this button to start the tumble dryer. The light close to the button will stop flashing and remain lit.

If you have selected a delay time option, the countdown will begin and will be shown on the display.

- Pause: when you press this button again, the programme in progress is interrupted. The light close to the button will start flashing. To restart the programme, press the button again.

If the door is opened while the programme is running the appliance immediately stops drying. The «Pause» message appears in the display and the  icon is shown above the Door button.

The appliance immediately stops drying, the «Pause» and «Please close condenser door» messages appear in the display also when the condenser door is opened.

This button must be pressed again after closing the door in order to restart the programme from the point at which it was interrupted.

This button must also be pressed after a power failure and after having re-inserted the water reservoir.

If it has been emptied in the middle of a programme after «The tank is full, please empty» message and an acoustic signal has sounded.

In both cases the light of the Start/Pause button flashes to remind you that the start button needs to be pressed again.

Programme Chart

Automatic drying (electronic programmes)

Type of laundry	Degree of drying required	Max-load ⁽¹⁾	Programme
COTTON	Extra dry	6 kg	Extra dry (COTTON EXTRA)
	Ready to wear	6 kg	Ready to wear (COTTON STRONG)
	Store dry	6 kg	Store dry(*) (COTTON CUPBOARD)
	Slightly damp	6 kg	Slightly damp (COTTON DAMP)
	Iron dry	6 kg	Iron dry(*) (COTTON IRON)
	Machine Iron Dry	6 kg	Machine Iron Dry (COT. MACHINE IRON)
SYNTHETIC	Extra dry	3 kg	Extra dry (EASYCARE EXTRA)
	Store dry	3 kg	Store dry(*) (EASYCARE CUPBOARD)
	Iron dry	3 kg	Iron dry (EASYCARE IRON)
JUMPERS	Baby dry	1 kg (10 jumpers)	Baby dry (BABY)

(*) According to IEC 61121 Standards.

- Baby Dry cycle  is a special programme for jumpers to be dried “READY TO WEAR”.

Time controlled drying

Type of laundry	Drying time	Max-load ⁽¹⁾	Programme selector dial position
COTTON	60'	6 kg	60 min
SYNTHETIC	30'	3 kg	30 min

(1) Never overfill the drum (do not load large quilts, for example).

Drying times vary according to:

- The type of laundry
- The size of the load
- The degree of spinning prior to drying.
- The degree of dryness required

Cooling

This position on the programme selector dial can be used to freshen the laundry (e.g. to remove a persistent odour of moth-balls).

Load

It is often difficult to estimate the weight of items to be dried. We therefore recommend that you adopt the following guidelines:

- **cotton, linen:** drum full but not too tightly packed;
- **synthetics:** drum no more than half full;
- **delicate fabrics:** drum no more than one third full.

Operating Sequence

Before using your tumble dryer for the first time, we recommend to place a few damp cloths inside the appliance and dry for 30 minutes. There may be dust inside a brand new tumble dryer.

Drying

1. Connect the appliance.
2. Open the door (see picture).

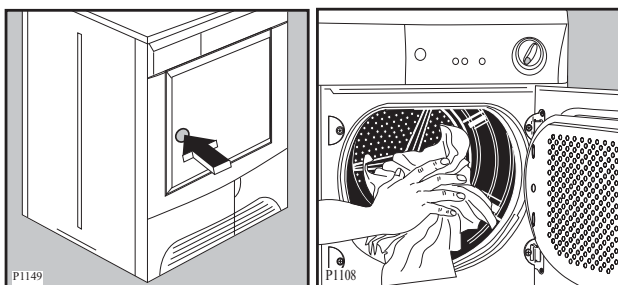

3. Load the items one at a time, shaking them out loosely.
4. Close the door. Please check the laundry does not get caught between the door and filter.
5. Turn the selector dial to the desired programme to switch the appliance on. To switch the appliance off turn it to «Reset/Off».

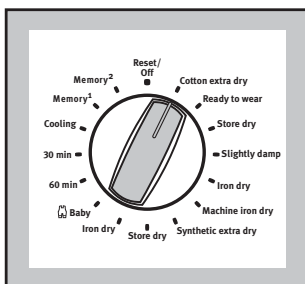

Switching on the appliance for the first time.

Language

When switching on the appliance for the first time you must set the language in which you want the indicators on the display to appear.

Important!

If the display is not showing any language, the appliance has already been switched on once. In such case, go to the chapter «Change language» if you would like to change the language setting.

Example:

Press the «Change» button until the desired language appears in the display.

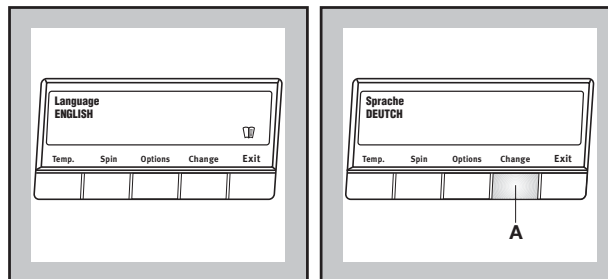

Press the EXIT button to confirm the selection.

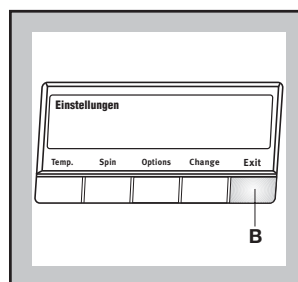

All indicators on the display will appear in this language from now on.

Note:

If the undesired language has been set, press the «Spin and Option» buttons simultaneously for about 3 seconds in order to change the language. Follow the instructions as before.

Setting the time

You should set the time prior to the first drying cycle and when changing to and from daylight savings time. See «Clock setting», Menu.

6. Turn the selector dial, in order to select the desired programme. The relevant message will appear in the display. The display will show the end cycle time «Cycle end at» of the selected programme, calculated on the basis of the maximum load for each type of fabric. The START/PAUSE button light will start flashing. If the load of laundry to be dried is small, at the beginning of the cycle the display will still indicate the end cycle relevant to the maximum load.

The duration value will be gradually adjusted during the execution of the drying cycle.

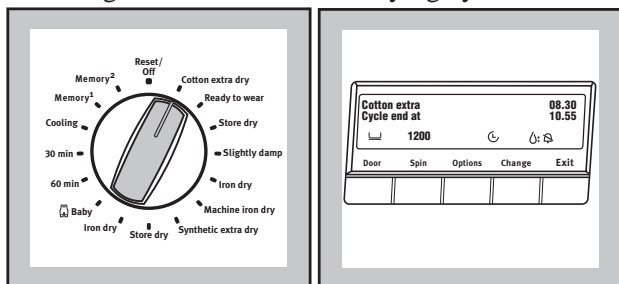

- Press the SPIN button repeatedly, in order to select the real spin speed that your laundry has been spun. The selected spin level will be shown on the third row above to the spin button.

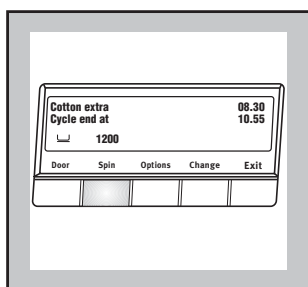

- Press the «Options» button to select the required options.

To confirm your choice press the «Change» button.

Depending on the selected programme only certain options are available and shown during the selection phase.

Note: Not all the options are compatible between themselves. The incompatible option icons will disappear.

- Select the DELAY START option if required.

Before you start the programme choose the required option.

The selected delay time value (up to 20 hours) will appear on the display while selecting.

The end cycle will be updated and shown on the relative position of the display.

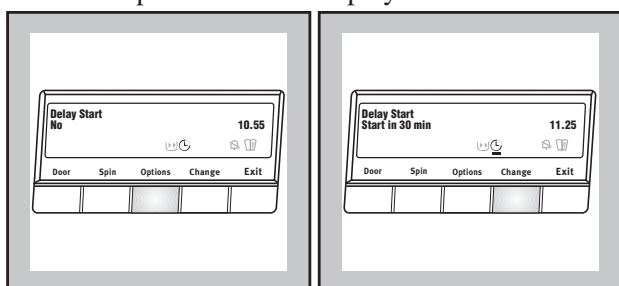

- Press the START/PAUSE button. The relevant light will stop flashing. The message relevant to the phase that is in progress will be shown in the display.

If you have chosen a delayed start, the tumble dryer will begin the countdown.

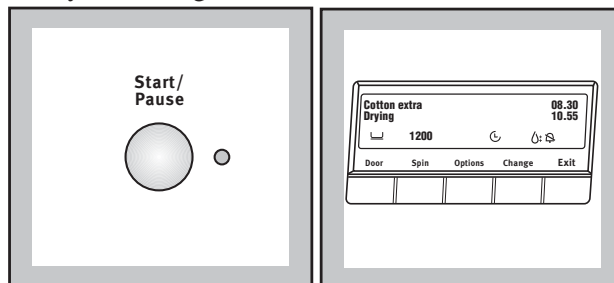

If the programme selector dial is turned to another position, when the machine is running, the buzzer will sound and the «**Selection error**» message appears in the display.

The drum turns alternately in both directions during drying.

All drying programmes end with a 10 minute cooling phase (on the second row of the display appears the «**Cooling**» message).

You may remove the laundry after this phase.

The display shows the following messages one after another: «**Please clean the filters**» and «**Please empty the tank**». The buzzer sounds to indicate the end of the cycle.

- If the laundry is not removed at the end of the cycle, the dryer performs an **anti-creasing** phase (duration: 30 minutes maximum).

If you do not remove the laundry, the dryer will stop automatically at the end of the anti-creasing phase. The display will show the following messages one after another: «**Anticrease**», «**Please clean the filters**» and «**Please empty the tank**». The buzzer sounds to indicate the end of the cycle.

The light of the START/PAUSE button goes off and a flashing zero appears on the display.

- Turn the programme selector dial to «**RESET/OFF**»; all the lights go out. The appliance is switched off.

Remove the laundry.

If you open and then close the door before turning the programme selector dial to «RESET/OFF», the machine is ready to perform another drying programme. The display shows the selected programme, duration of the programme and the options required.

After each use

- Clean the filters (see page 16).
- Empty the water reservoir (see page 17).

Important!

If the drying programme has to be stopped before it reaches the end, we recommend that you turn the programme selector dial to position «Cooling» and wait until the end of this phase before removing the laundry. This will avoid a build-up of heat inside the appliance. To do this first turn the dial to «**Reset/Off**» and then to «**Cooling**» and press Start/Pause button.





Modifying the programme

To change a programme which is running, first cancel it by turning the programme selector dial to «**Reset/Off**». Select the new programme and press the Start/Pause button.

Hints & Tips on Drying

Before placing articles of laundry in your tumble dryer, check the care labels to ensure they are recommended for tumble drying.

Care Labels you may find on your laundry

-  may be tumble dried
-  normal drying (high temperature)
-  delicate drying (low temperature)
-  do not tumble dry

 **Do not overload the appliance.**

Here is a list of the approximate weight of some common laundry items.

Sheet	700 to 1000 g
Pillowcase	100 to 200 g
Tablecloth	400 to 500 g
Table Napkin	50 to 100 g
Kitchen Towel	70 to 120 g
Linen Hand Towel	100 to 150 g
Hand Towel	150 to 250 g
Bath Towel	700 to 1000 g
Bathrobe	1000 to 1500 g
Shirt	200 to 300 g
Apron	150 to 200 g

- Always load well spun laundry. The higher the spin speed the lower the electricity consumption and the shorter the drying time.
- **DO NOT** load dripping wet laundry into the dryer. Roll the article in a towel or spin to remove excess water.
- Close poppers and zips and fasten any buttons.
- Sort the laundry. Separate synthetics from cotton/linens, and dry separately.
- Remove the laundry immediately after the programme has finished.
- Use a fabric conditioning sheet to reduce static. We recommend the sheet is pinned to an article of laundry (using a safety pin).
- Mix the load i.e. large and small articles.
- When drying large items such as sheets, we recommend you periodically stop the dryer to redistribute the load.

DO NOT use the tumble dryer to dry the following:

- Articles contaminated with inflammable substances e.g. petrol, cleaning solvents, cooking oil, fats or hair lacquer.
- Woollen and synthetic/wool mixtures unless the item is labelled as suitable for tumble drying.
- Very delicate articles such as silk.
- Very large and bulky items such as duvets or sleeping bags.

Maintenance and Cleaning

You must **disconnect** the appliance from the electricity supply, before you can carry out any cleaning or maintenance work.

External cleaning

Use water with a little mild washing-up liquid added rinse and then dry thoroughly.

Important: do not use methylated spirit, diluents or similar products.

Cleaning the door

Clean periodically the interior part of the door to remove any fluff from the seals around the filter. Regular cleaning ensures correct drying.

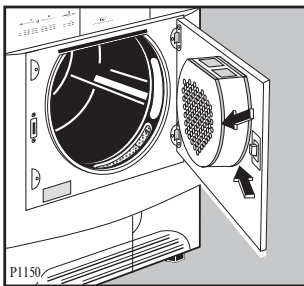

Cleaning the filters

Your dryer will only function well if the filters are clean.

The filters collect all the fluff which accumulates during drying and they must therefore be cleaned at the end of each programme, before removing the laundry, with a damp cloth. The «**Please clean filters**» message appears on the display to remind you to carry out this operation.

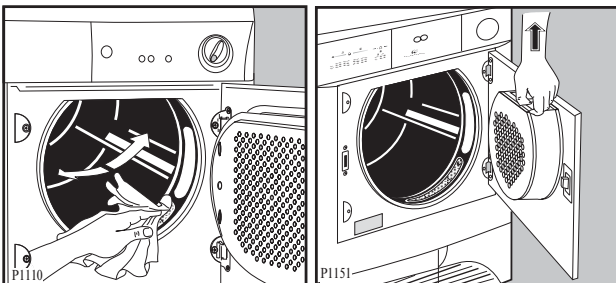

The filter in the inner door must be removed for cleaning.

Do not be alarmed by the amount of fluff. It is not due to excessive wear caused by the dryer. All fabric loses fluff when drying but it goes un-noticed in the air. In a tumble dryer it simply collects in the filter.

After a while, a whitish patina due to detergent residue on laundry forms on the filters. When this occurs, clean the filters with warm water using a brush. Remove the filter in the door opening as per picture (it can be positioned with the tooth facing to the left or to the right).

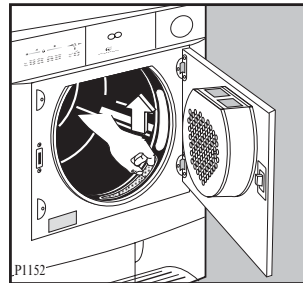

! Do not use the appliance without filters.

Cleaning the condenser unit

Clean the air condenser when the «**Please clean condenser**» message appears on the display.

The condenser is situated at the lower part of the cabinet behind a small door. To open the door, push the catch as per picture.

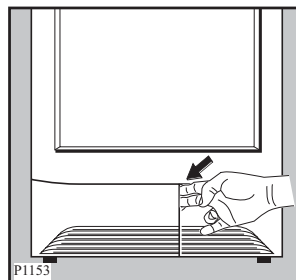

During the drying cycle or at the end, it is normal for water to be present on the surface of the condenser.

To pull out the condenser, first turn the two red stops downwards as shown below and then remove the condenser unit holding it at the handle.

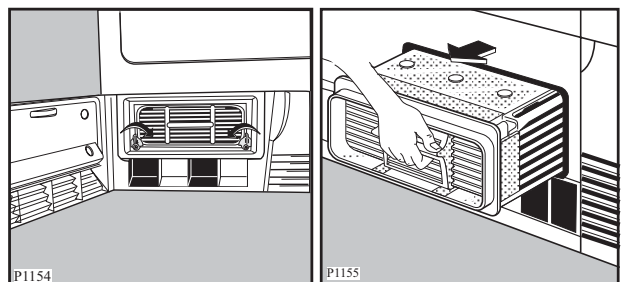

Clean it with a brush and rinse it under the shower if necessary.

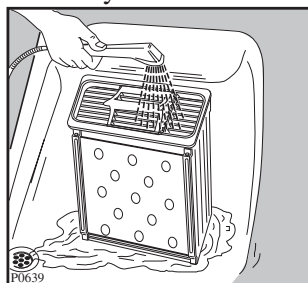

Also clean the outside, removing all fluff.

Clean the rubber seal round the condenser cabinet and in the inner part of the small door with a damp cloth.

Important! Do not use pointed objects or utensils to clean the spaces between the plates, as this could damage the condenser and make it permeable.

Re-fit the condenser, turn the red stops upwards and close the door.



Do not use this appliance if the condenser has not been fitted.

The reservoir must be re-inserted correctly.

If this is not done the same message comes on during next drying and the programme stops, leaving the laundry damp. The buzzer will sound.

After inserting the reservoir the START/PAUSE button has to be pressed again to allow the programme to continue.

Handy tip: The condensed water may be used in a steam iron or to top up a battery, etc. In this case it must be filtered (e.g. through a coffee filter).

Cleaning the drum

When your laundry does not reach the desired degree of dryness, in other words, when it turns out either too dry or too damp, we advise you to clean the inside of the drum with a cloth soaked with vinegar.

This will eliminate the slight patina that has formed in the drum (due to residues of detergent and softeners used in the washing, and to the lime contained in the water), which prevents the probes from detecting the correct degree of dryness.

Emptying the water reservoir

Water extracted from the laundry condenses inside the machine and is collected in a reservoir.

The reservoir must be emptied after each drying cycle to ensure efficient operation when the machine is next used.

The message «**The tank is full, please empty**» written on the display reminds you to do this.

Proceed as follows:

- Pull out the reservoir
- Turn it upside down and let water flow down
- Re-fit the reservoir

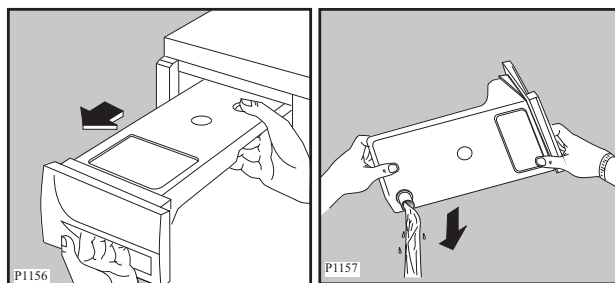

Something Not Working

Certain problems are due to lack of simple maintenance or oversights, which can be solved easily without calling out an engineer. Before contacting your local Service Centre, please carry out the checks listed below.

During machine operation it is possible that one of the following messages appears on the display:



Problem with filters/condenser«**Please clean filters/condenser**» Please check filters/condenser.

Problem with water reservoir«**The tank is full, please empty**» Please check the water reservoir.

Door open«**Can't lock door**» Please check the door.

Once the problem has been eliminated, press the START/PAUSE button to restart the programme.

IMPORTANT: if the «Warning» message and an alarm code (e.g. E21) appear on the display and the buzzer sounds, switch the machine off and call the Service Centre.

Symptom	Possible causes
The tumble dryer does not start	<ul style="list-style-type: none"> ● The door(s) has (have) not been closed («Can't lock door»). ● The plug is not properly inserted in the power socket. ● There is no current at the socket. ● The main fuse or the fuse in the plug has blown. ● The selector dial is not set correctly. ● The water reservoir is full or not properly inserted («The tank is full, please empty»). The programme starts in any case but it stops after approx. 4 minutes. ● The START/PAUSE Button has not been pressed. ● The DELAY START option has been selected.
Drying takes too long or laundry is not dry enough.	<ul style="list-style-type: none"> ● The laundry has not been spun properly. ● The filters and/or the condenser are clogged up («Please clean filters/condenser»). ● The water reservoir is full («The tank is full, please empty»). ● The room temperature is too high. ● The selected time or drying cycle was not suitable for the laundry. ● The HALF POWER  option has been selected. ● The HALF LOAD  option has been selected. ● There is too much laundry inside the appliance. ● The dryer is not correctly installed.

If after the above checks, there is still a fault, call your local Service Force Centre.

Service & Spare Parts **SERVICE FORCE**

In the event of your appliance requiring service, or if you wish to purchase spare parts, please contact your local Service Force Centre by telephoning:

0870 5 929929

Your telephone call will be automatically routed to the Service Force Centre covering your post code area.

For the address of your local Service Force Centre and further information about Service Force, please visit the website at www.serviceforce.co.uk.

Before calling out an engineer, please ensure you have read the details under the heading "Something Not Working".

When you contact the Service Force Centre you will need to give the following details:

1. Your name, address and post code
2. Your telephone number
3. Clear and concise details of fault
4. The model and serial number of the appliance (found on the rating plate - see picture)
5. The purchase date.

Please note that a valid purchase receipt or guarantee documentation is required for in-guarantee service calls.

To buy accessories, consumables and spare parts at our online shop please visit:
<http://www.zanussi-electrolux.co.uk>

Customer Care Department

For Customer Services in the Republic of Ireland please contact us at the address below:

Zanussi-Electrolux
Electrolux Group (Ire) Ltd
Long Mile Road
Dublin 12
Republic of Ireland
Tel: +353 (0) 1 4090751
Email: service.eid@electrolux.ie

For general enquiries concerning your Zanussi Electrolux appliance or for further information on Zanussi Electrolux products, please contact our Customer Care Department by letter or telephone at the address below or visit our website at www.zanussi-electrolux.co.uk

Customer Care Department

Major Appliances

Addington Way
Luton
Bedfordshire
LU4 9QQ
Tel 08705 727727*

* calls to this number may be recorded for training purposes.

Guarantee Conditions

Standard guarantee conditions

We, Zanussi Electrolux, undertake that if, within 12 months of the date of the purchase, this ZANUSSI ELECTROLUX appliance or any part thereof is proved to be defective by reason only of faulty workmanship or materials, we will, at our option repair or replace the same **FREE OF ANY CHARGE** for labour, materials or carriage on condition that:

- The appliance has been correctly installed and used only on the electricity supply stated on the rating plate.
- The appliance has been used for normal domestic purposes only, and in accordance with the manufacturer's instructions.
- The appliance has not been serviced, maintained, repaired, taken apart or tampered with, by any person not authorised by us.
- All service work under this guarantee must be undertaken by a Service Force Centre.
- Any appliance or defective part replaced shall become the Company's property.
- This guarantee is in addition to your statutory and other legal rights.

Home visits are made between **8.30am** and **5.30pm** Monday to Friday. Visits may be available outside these hours in which case a **premium** will be charged.

Exclusions

This guarantee does not cover:

- Damage or calls resulting from transportation, improper use or neglect, the replacement of any light bulbs or removable parts of glass or plastic.
- Costs incurred for calls to put right an appliance which is improperly installed or calls to appliances outside the United Kingdom.
- Appliances found to be in use within a commercial environment, plus those which are subject to rental agreements.
- Products of Zanussi Electrolux manufacture which are **NOT** marketed by Zanussi Electrolux.

European guarantee



If you should move to another country within Europe then your guarantee moves with you to your new home subject to the following qualifications:

- The guarantee starts from the date you first purchased your product.
- The guarantee is for the same period and to the same extent for labour and parts as exists in the new country of use for this brand or range of products.
- The guarantee relates to you and cannot be transferred to another user.
- Your new home is within the European Community (EC) or European Free Trade Area.
- The product is installed and used in accordance with our instructions and is only used domestically, i.e. a normal household.
- The product is installed taking into account regulations in your new country.

Before you move please contact your nearest Customer Care Centre, listed below, to give them details of your new home. They will then ensure that the local Service Organisation is aware of your move and able to look after you and your appliances.

France	Senlis	+33 (0)344 62 29 29
Germany	Nurnberg	+49 (0)800 234 7378
Italy	Pordenone	+39 (0)434 394 700
Sweden	Stockholm	+46 (0)867 253 90
UK	Luton	+44 (0)870 572 7727

Installation Instructions

-  It is dangerous to alter the specifications or attempt to modify this product in any way.
-  Care must be taken to ensure that the appliance does not stand on the electrical supply cable.
-  Any electrical work required to install this appliance should be carried out by a qualified electrician or competent person.

Technical Specifications

DIMENSIONS	Height Width Depth	85 cm (33.5") 60 cm (23.6") 58 cm (22.8")
POWER SUPPLY VOLTAGE TOTAL POWER ADSORBED		240 V/50 Hz 2450 W (13A)
MAX LOAD CAPACITY	Cotton, linen Synthetics	6 kg (13.2 lbs) 3 kg (6.6 lbs)
DRUM VOLUME		108 l
CONSUMPTIONS	Cotton, linen Cotton, linen Synthetics	3.84 kWh (6 kg store dry) 3.30 kWh (6 kg iron dry) 1.60 kWh (3 kg store dry)

-  This appliance complies with the following E.E.C. Directives:
- 73/23 EEC of 19.2.73 (Low Voltage Directive) and subsequent modifications;
 - 89/336 EEC of 3.5.89 (Electromagnetic Compatibility Directive) and subsequent modifications.

Adjusting the Level of Conductivity

Water contains, a variable quantity of limestone and mineral salts of which quantities vary according to geographical locations thus varying its conductivity values.

Relevant variations of the conductivity of the water compared to those prefixed by the factory could slightly influence the residual humidity of the laundry at the end of the cycle.

Your dryer allows you to regulate the sensitivity of the drying sensor based on conductivity values of the water by using the following procedure.

Procedure:

Turn the programme selector dial to switch on the appliance.

In selection mode press the «**Option**» button until the **Set Up** menu appears on the display.

Press «**Change**» button to enter in the Set Up menu and then press the «**Option**» button sequentially until the message «**Water hardness**» appears.

Adjusting the level of conductivity:

Pressing «**Change**» button you can choose the required water hardness degree.

The level of water hardness is indicated by 3 degree shown on the display: hard, normal and soft.

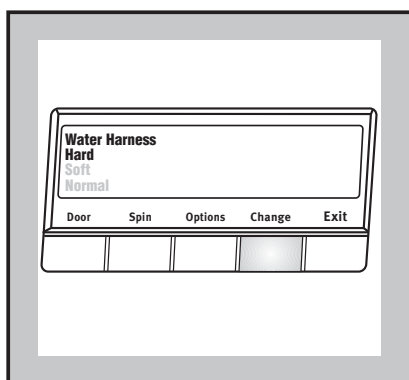

Display	Conductivity degree	Approximative value °dH
SOFT	Low	< 14
NORMAL	Medium	15 - 21
HARD	High	> 21

Memorising the new setting:

To fix your choice press the «**Exit**» button.

The previous selected drying cycle and options appears again on the display and the buzzer sounds.

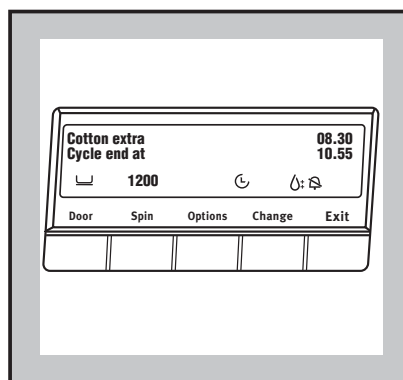
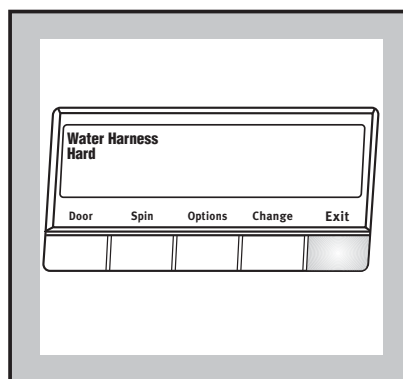

Normally, the appliance is factory-set to the highest level; however, certain models may be configured differently.

Unpacking

Warning !

-  Slide out the polythene bag containing the polystyrene block before using the appliance.
- Pull off adhesive strips from inside machine on top of drum

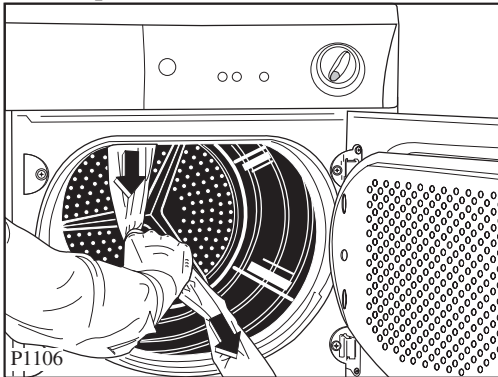

-  **Should the appliance be moved, it must be transported vertically.**

Positioning

It is recommended that, for your convenience, the machine is positioned close to your washing machine.

The tumble dryer must be installed in a clean place, where dirt does not build up.

Air must be able to circulate freely all round the appliance. Do not obstruct the front ventilation grill or the air intake grills at the back of the machine.

To keep vibration and noise to a minimum when the dryer is in use, it should be placed on a firm, level surface.

Once in its permanent operating position, check that the dryer is absolutely level with the aid of a spirit level. If it is not, raise or lower the feet until it is.

The feet must never be removed.

Do not restrict the floor clearance through deep-pile carpets, strips of wood or similar. This might cause heat build-up which would interfere with the operation of the appliance.

Important

The hot air emitted by the tumble dryer can reach temperatures of up to 60°C. The appliance must therefore not be installed on floors which are not resistant to high temperatures.

When operating the tumble dryer, the room temperature must not be lower than +5°C and higher than +35°C, as it may affect the performance of the appliance.

Stacking kit (optional accessory)

It should be possible to stack your new dryer on top of a front loading washing machine with a lid depth of between 48 and 60 cm.

Read carefully the instructions supplied with the kit.

Please contact your local Service Force Centre or retailer for further advice.

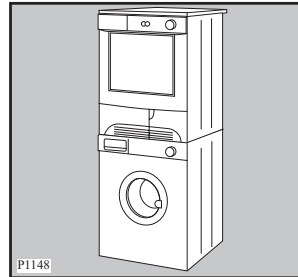

Door reversal

To make it easier to load or unload the laundry the door can be reversed.

This operation must be carried out by a Service Force Engineer.

This will be a chargeable option

Please contact the nearest Zanussi-Electrolux Service Force Centre.

Electrical connection

Any electrical work required to install this appliance should be carried out by a qualified electrician or competent person.

-  **WARNING: THIS APPLIANCE MUST BE EARTHED.**

The manufacturer declines any liability should this safety measure not be observed. Should the appliance power supply cable need to be replaced, this must be carried out by our Service Centre.

Before switching on, make sure the electricity supply voltage is the same as that indicated on the appliance's rating plate. (See picture on page 4).

The appliance is supplied with a 13amp plug fitted. In the event of having to change the fuse in the plug supplied, a 13amp ASTA approved BS 1363/A fuse must be used.

Should the plug need to be replaced for any reason, proceed as described below. The wires in the mains lead are coloured in accordance with the following code:

- Green and Yellow - Earth
- Blue - Neutral
- Brown - Live

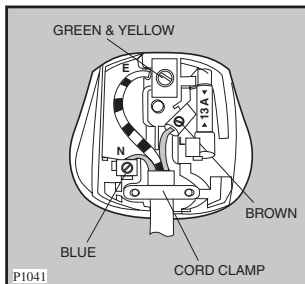

The wire coloured green and yellow must be connected to the terminal marked with the letter «E» or by the earth symbol \equiv or coloured green and yellow.

The wire coloured blue must be connected to the terminal «N» or coloured black.

The wire coloured brown must be connected to the terminal marked «L» or coloured red.

Upon completion there must be no cut, or stray strands of wire present and the cord clamp must be secure over the outer sheath.

WARNING:

 **A cut off plug inserted into a 13 amp socket is a serious safety (shock) hazard. Ensure that the cut off plug is disposed of safely.**

Permanent connection

In the case of permanent connection it is necessary that you install a double pole switch between the appliance and the electricity supply (mains), with a minimum gap of 3mm between the switch contacts and of a type suitable for the required load in compliance with the current electrical regulations.

The switch must not break the yellow and green earth cable at any point.

 **From the Electrolux Group. The world's No. 1 choice.**

The Electrolux Group is the world's largest producer of powered appliances for kitchen, cleaning and outdoor use. More than 55 million Electrolux Group products (such as refrigerators, cookers, washing machines, vacuum cleaners, chain saws and lawn mowers) are sold each year to a value of approx. USD 14 billion in more than 150 countries around the world.